

US Formliner artico[®]

NEO
NEO
NEO
NEO
NEO
NEO

US Formliner
artico®

NEO
NEO
NEO
NEO

NEO
NEO
NEO
NEO

NEO
NEO
NEO
NEO

- 
- ⑥ US Formliner artico® neo
 - ⑩ Inspiration
 - ⑳ US Formliner artico® neo Design
 - ㉔ US Formliner artico® neo Individual
 - ㉘ Imprint



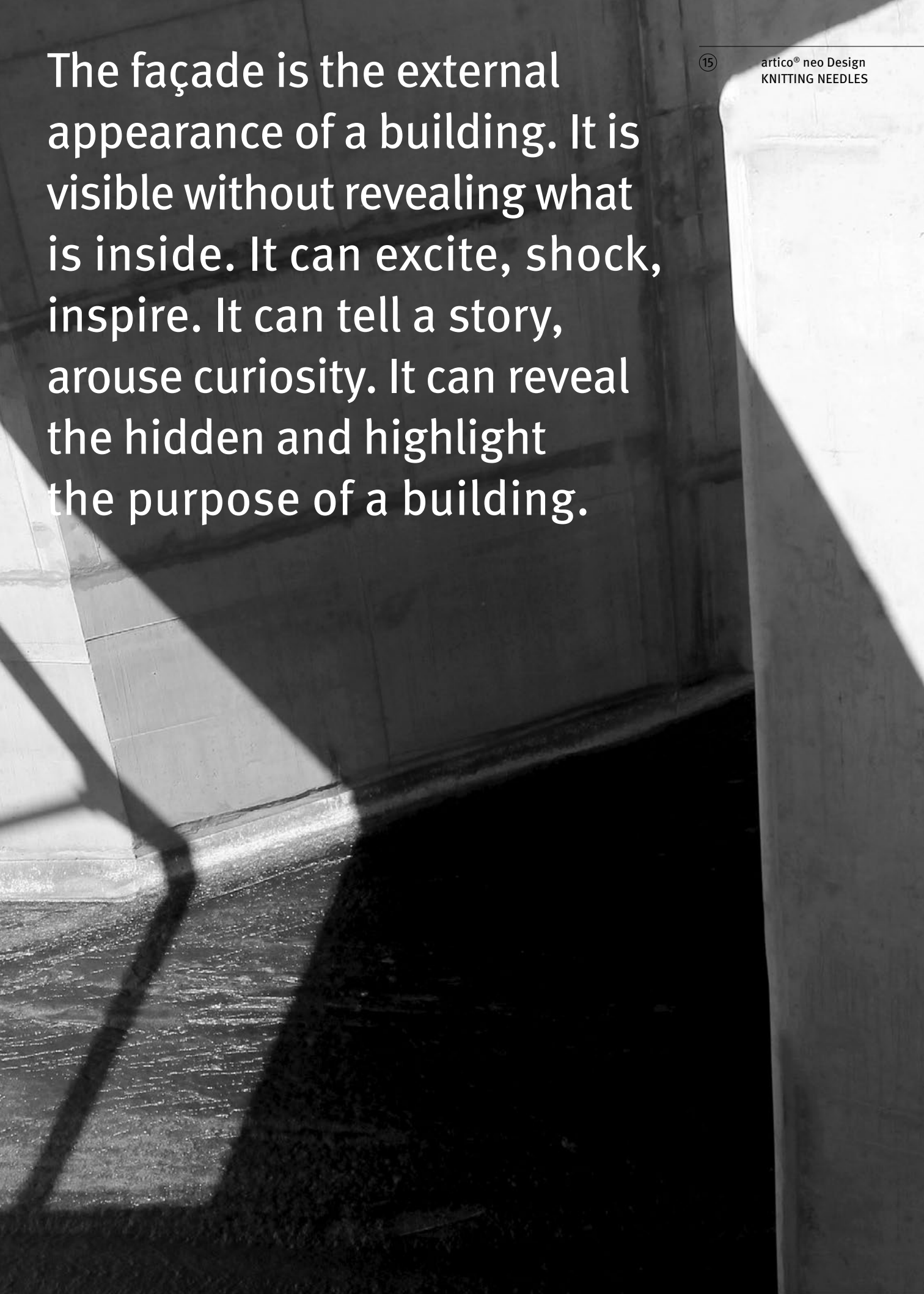

The façade is the external appearance of a building. It is visible without revealing what is inside. It can excite, shock, inspire. It can tell a story, arouse curiosity. It can reveal the hidden and highlight the purpose of a building.

US Formliner

artico[®]



neo

US Formliner artico® neo complements the creative freedom for architectural concrete with an essential component. Photos, images, individual designs and graphics can be made visible with this procedure – regardless of lighting conditions. That is why US Formliner artico® neo is also perfectly suited for use in interiors.

The process is simple:

US Formliner artico® neo is a plastic foil on which graphics or photos are printed with a high quality concrete activator. The concrete activator causes the concrete to set at a delayed time so that it can be washed out on the surface after demolding. The uppermost cement skin is partially removed. The contrast between the washed out and smooth surfaces makes the graphics or photos visible. The foils are intended for single use.

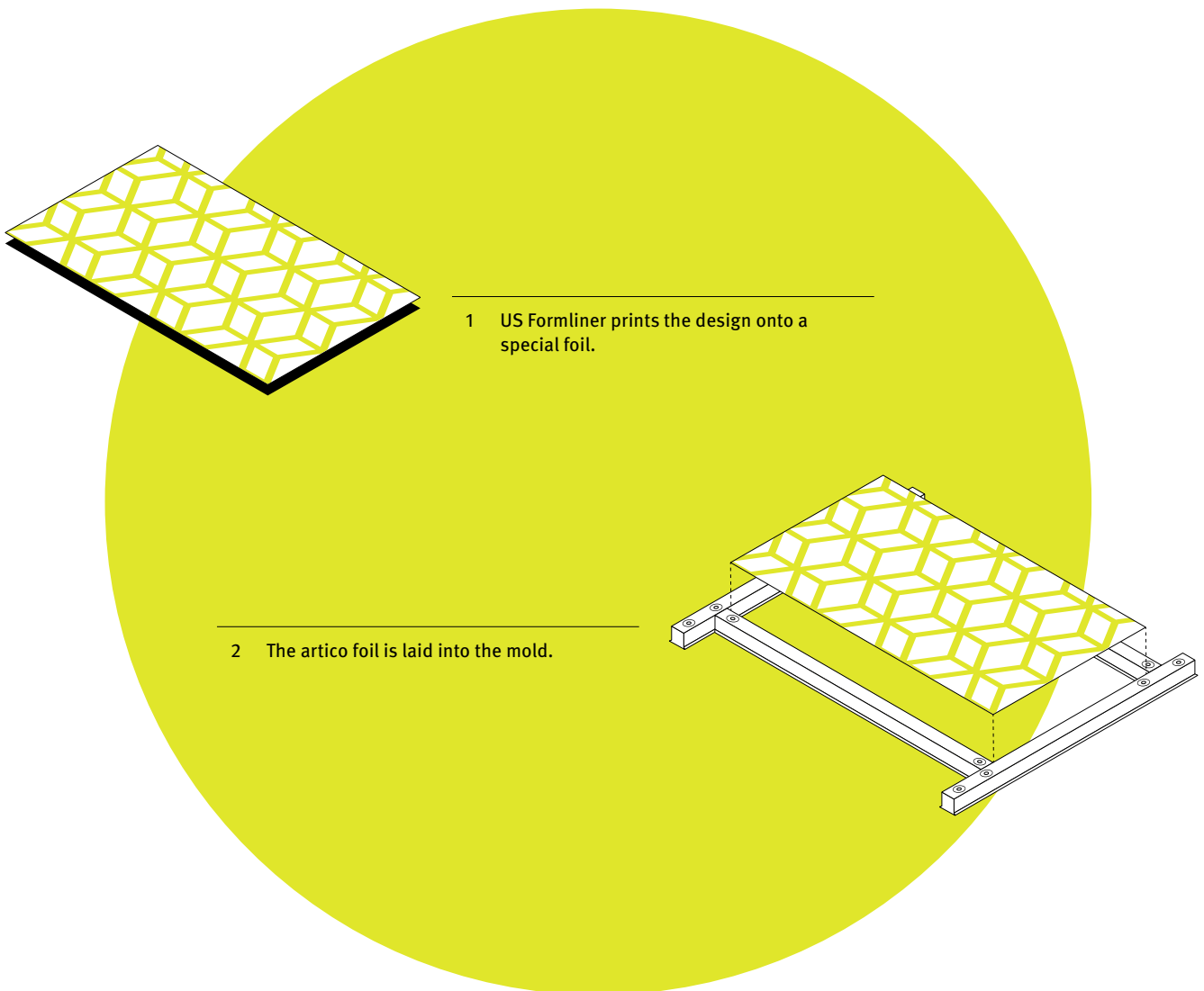

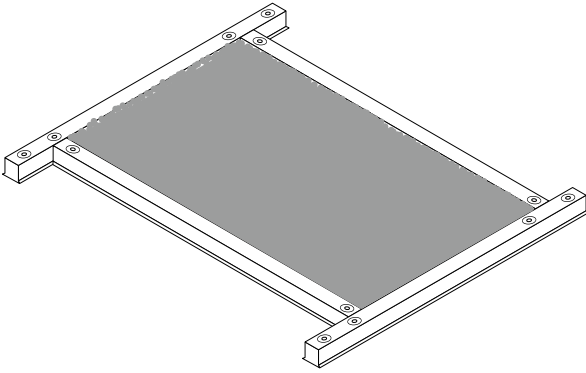

3 The concrete is poured into the mold.

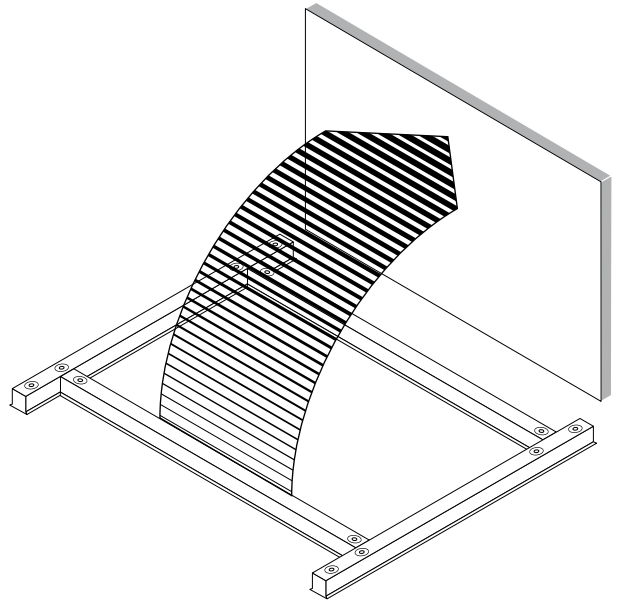

4 Once the concrete has hardened, the concrete element can be demolded.

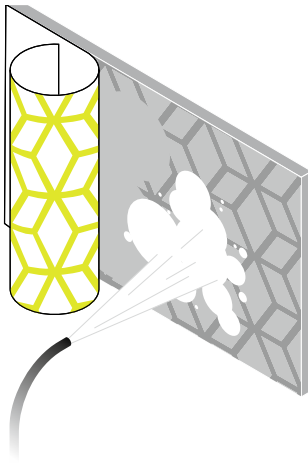

5 The foil is simply removed from the concrete element and the concrete is washed out with a high-pressure cleaner.

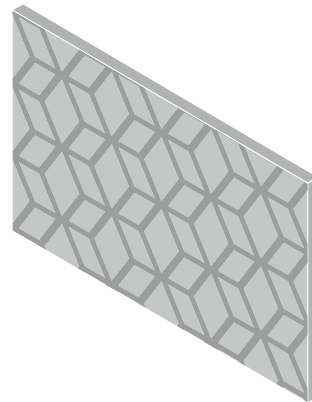

6 The interplay of washed out and smooth surfaces makes the design visible.

NEO
NEO
NEO

NEO
NEO
NEO

NEO
NEO
NEO

NEO
NEO
NEO

NEO
NEO
NEO

NEO
NEO
NEO















9

artico® neo Design
PASSTTSCHO





MEZZANINE

③

artico® neo Design
CUBES

US Formliner

artico®

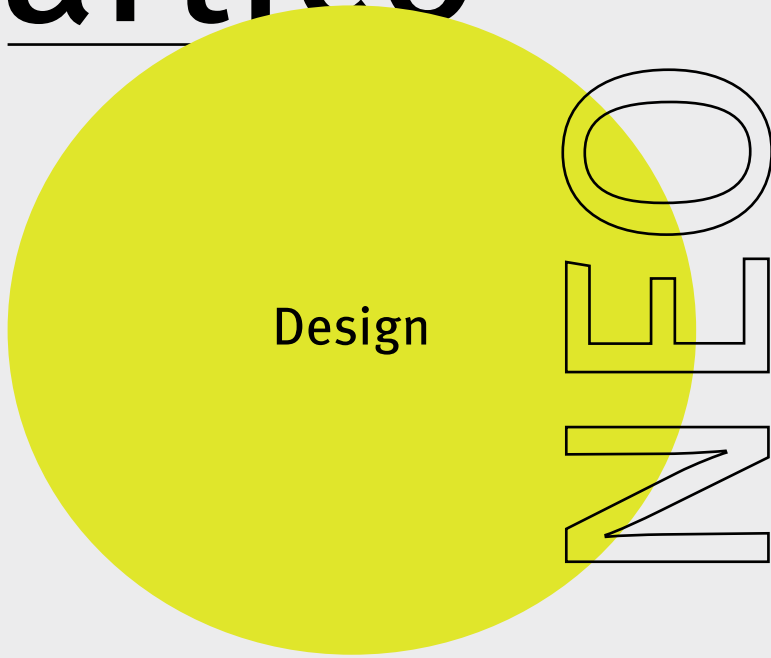

With our artico neo Design Collection, we present motifs which are available as standard offering. With a maximum size of 10.171 ft × 82.021 ft we supply these designs in rolls. The sheets can easily be cut on site to the desired size. The designs can be repeated both horizontally and vertically.

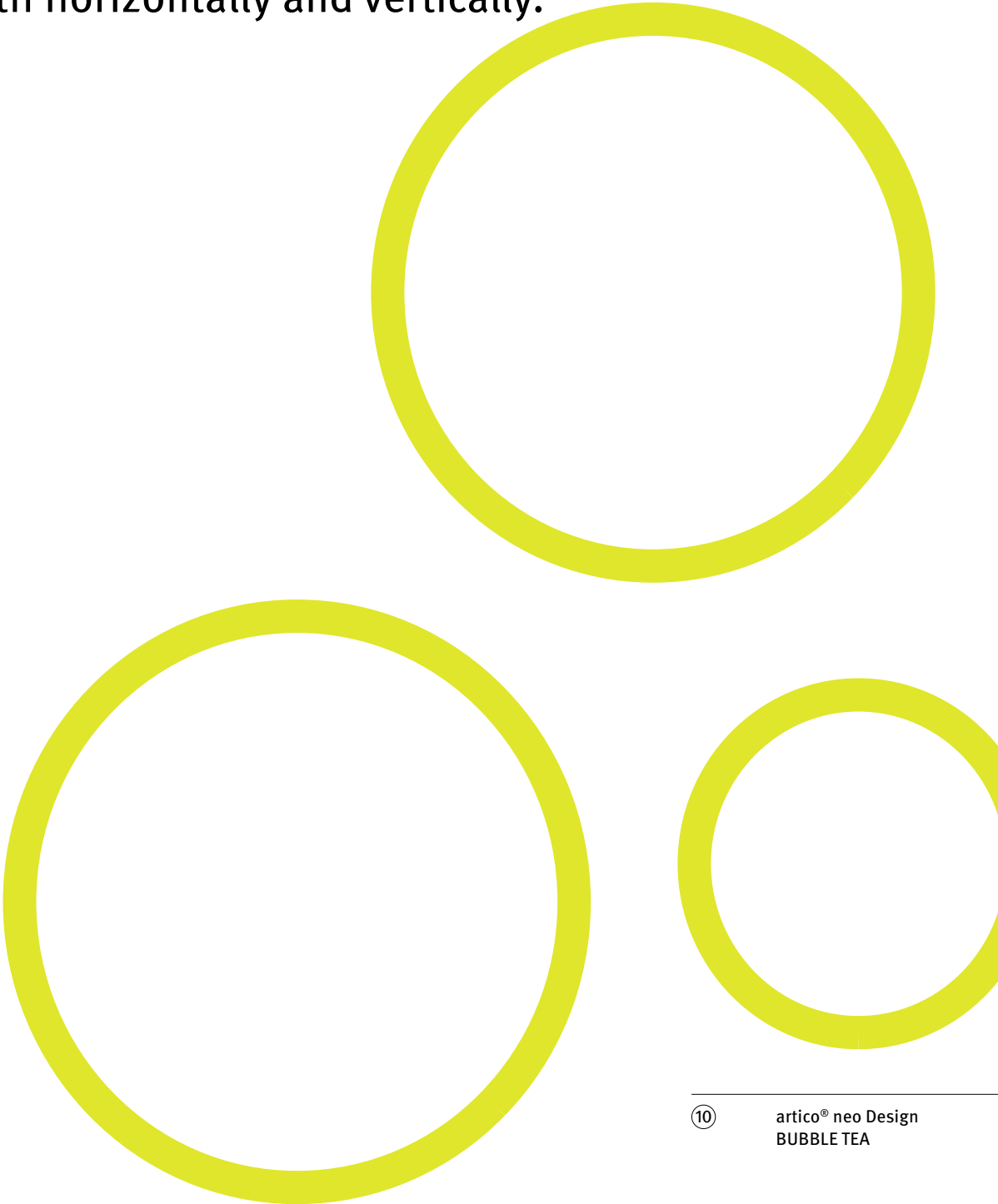

⑩

artico® neo Design
BUBBLE TEA

① BE SQUARED

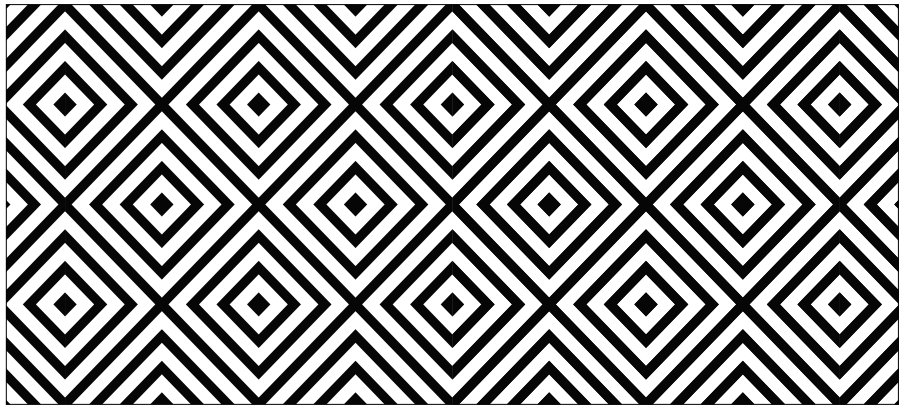

② CUPCAKES

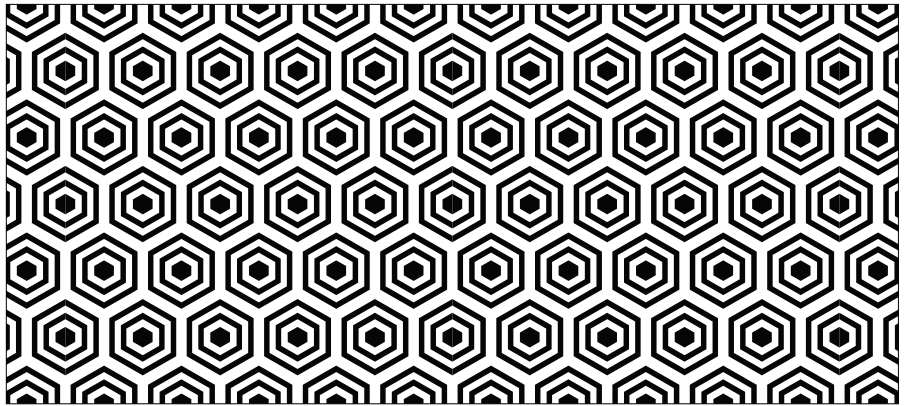

③ CUBES

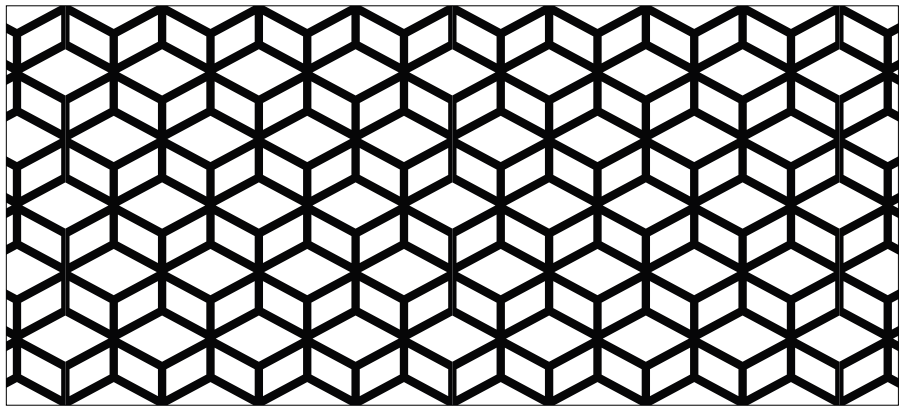

④ FLOWER POWER

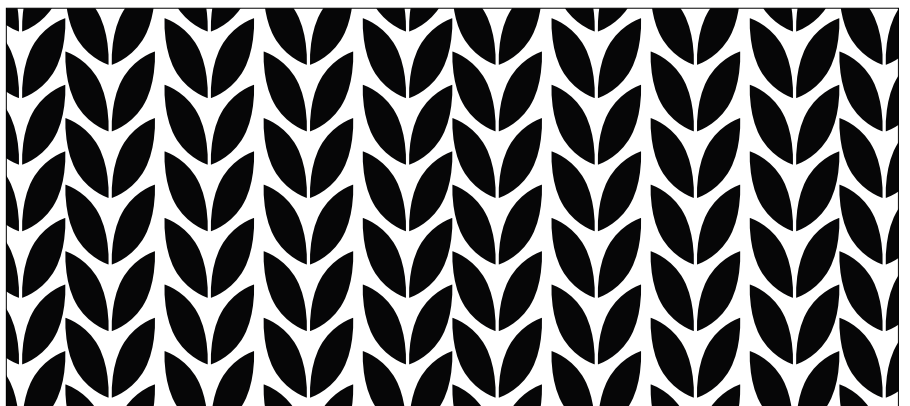

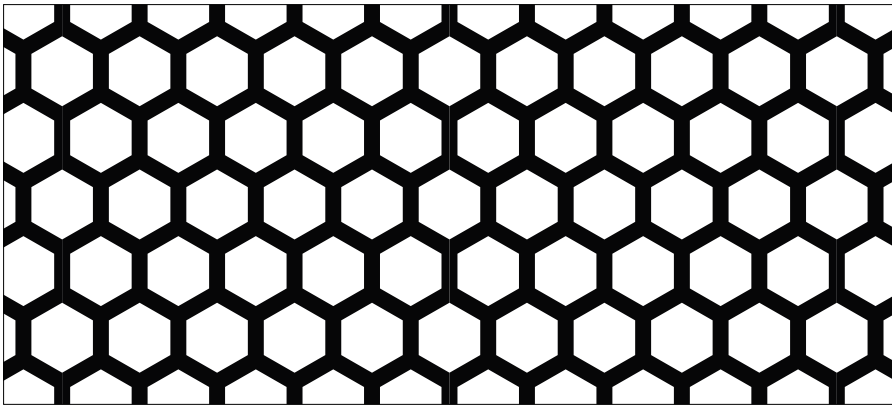

⑤

HONEY BEES

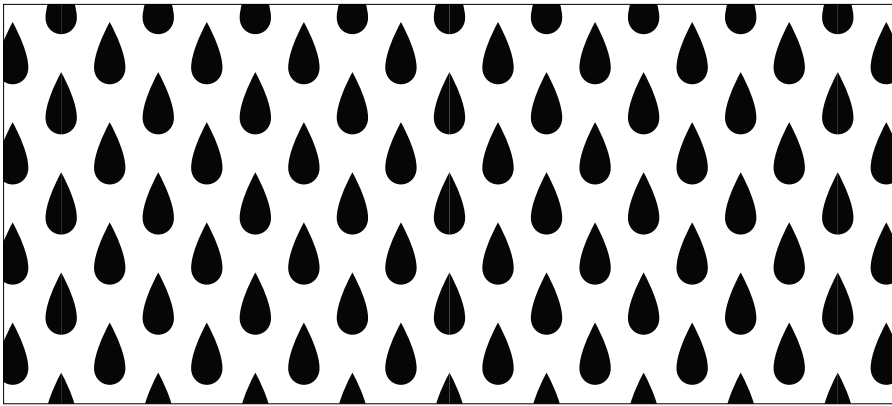

⑥

DRIP DROPS



⑦

METRO



⑧

FLAMES OF PARADISE

⑨ PASSTSCHO

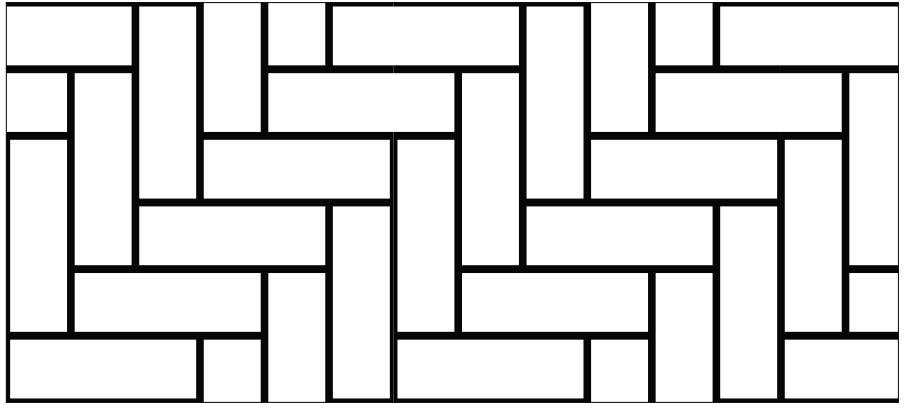

⑩ BUBBLE TEA

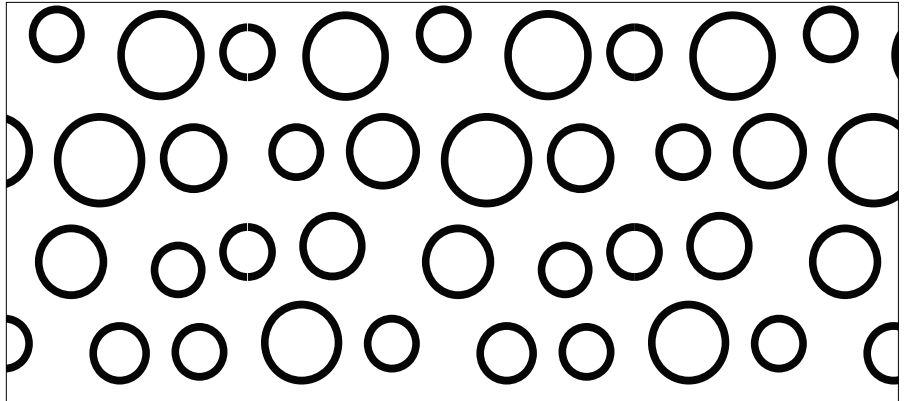

⑪ CASKET

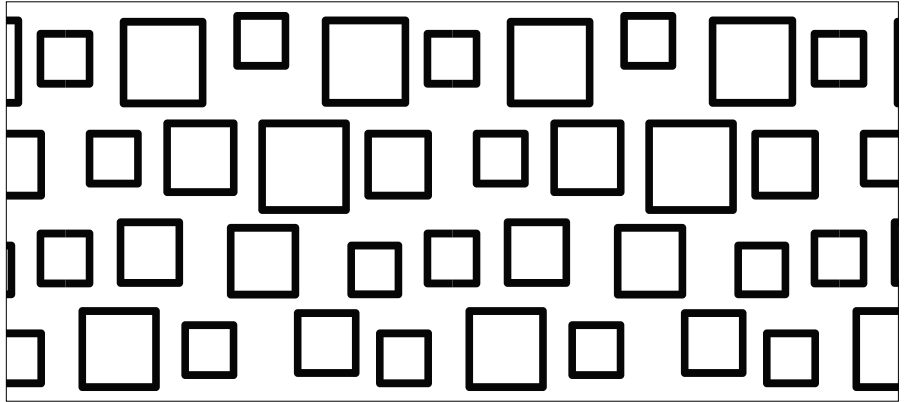

⑫ GAME CONTROL

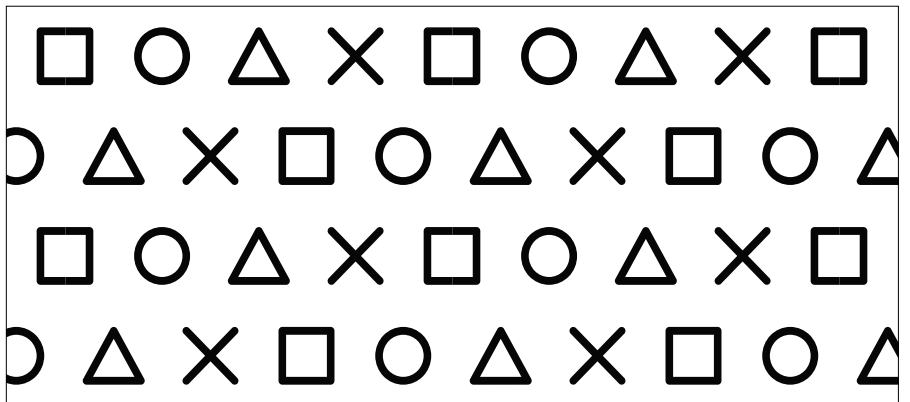

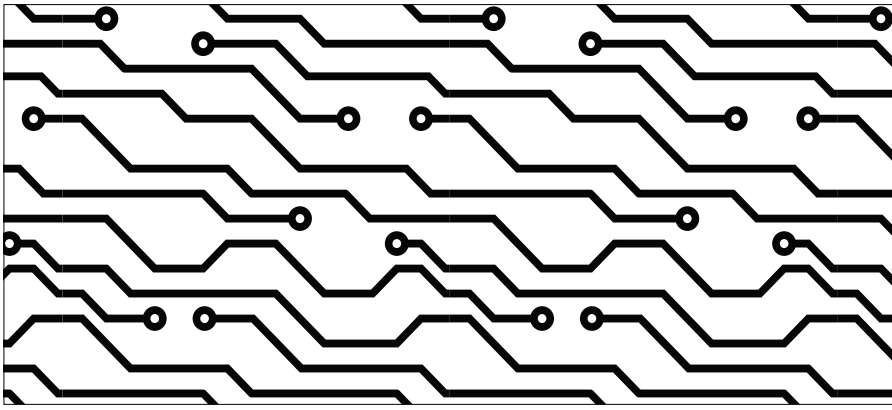

13

BIG DATA

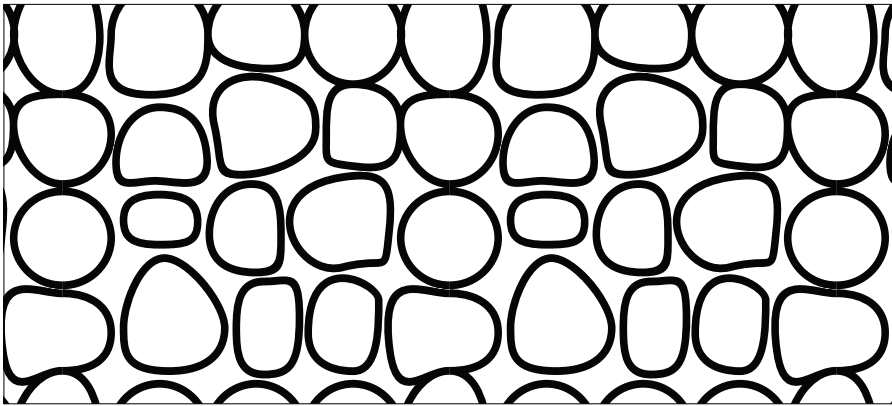

14

STONEHENGE

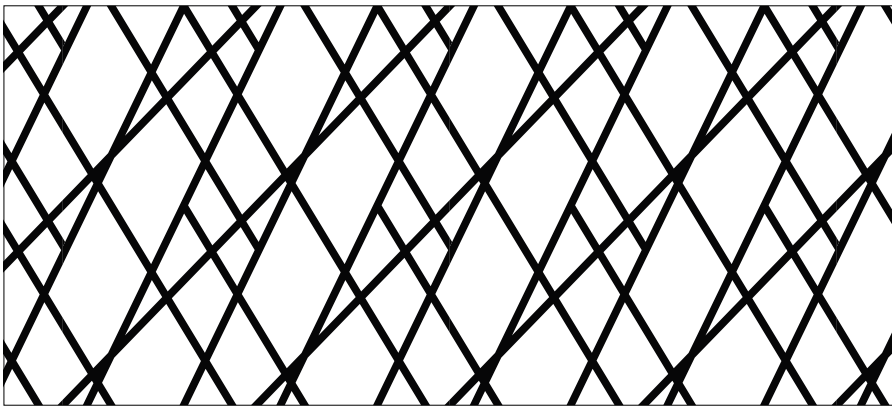

15

KNITTING NEEDLES

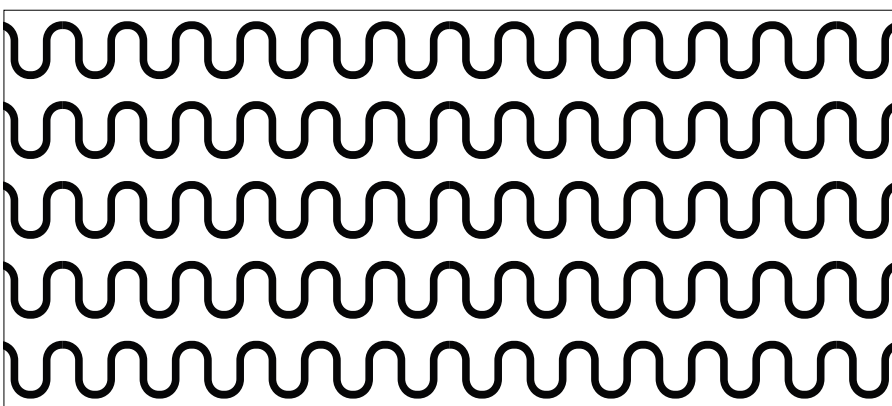

16

ZIPPER

US Formliner

artico®

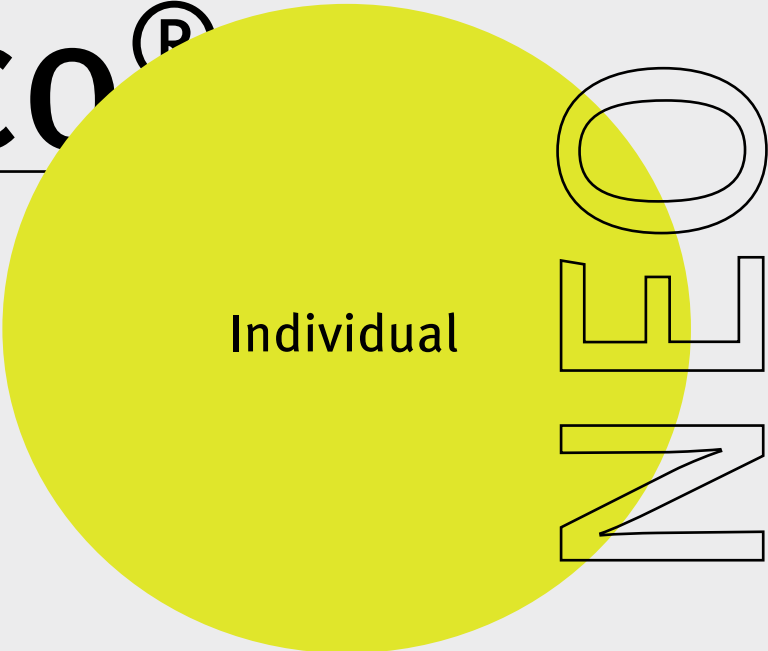



Your custom design or photo is printed in the max. dimension of 10.171 ft × 82.021 ft on a plastic foil and cut to the desired size.

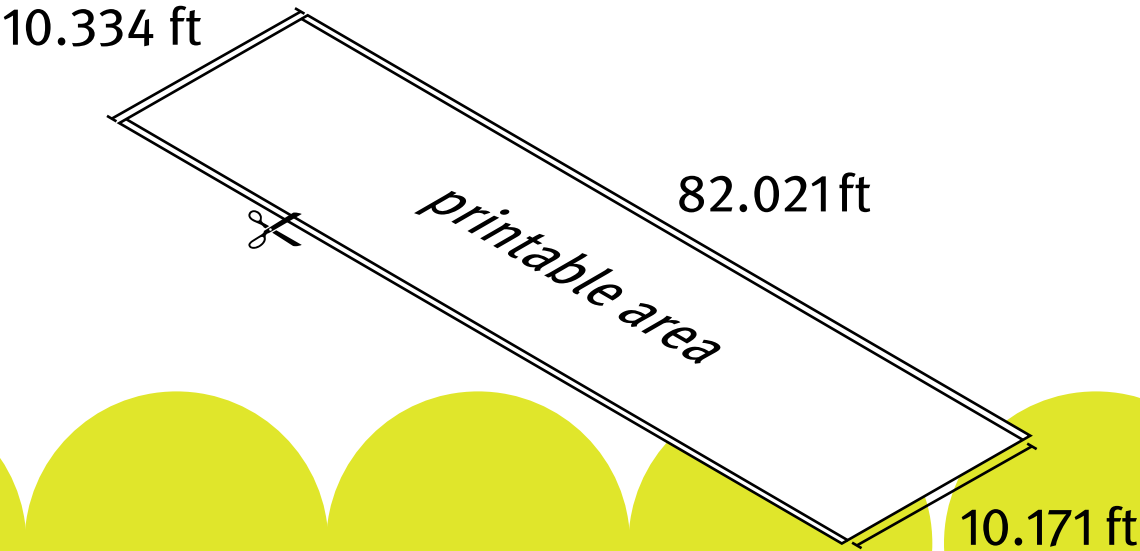

We prepare the files and send a visualization upon request. Photos are fragmented into halftone dots just like in newspaper printing. Their size depends on the reference image and the viewing distance and is defined by project specifics.

We can also produce sample films for a fee. In this way, the precast factory can optimize their concrete formula.

Once produced, designs can be reordered at any time. Due to the efficient manufacturing process, there are no setup costs.

The process requires tif-, jpeg- or bmp files. For this application PDF files are not well suited.

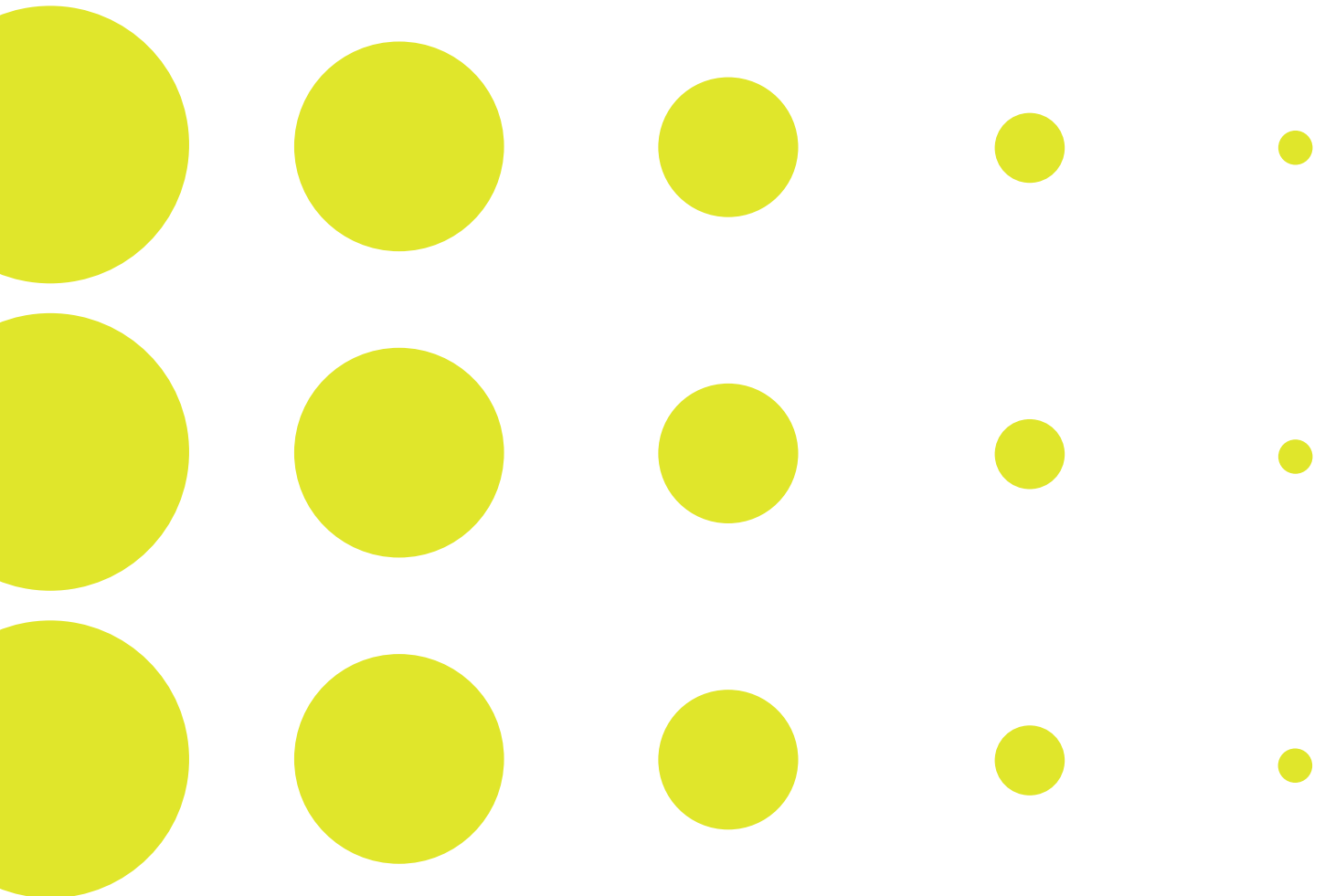



Architectural
concrete with a
depth effect:
light-independent
visualization of
photos and graphics
in the concrete
surface. For unlimited
freedom of design.





US Formliner Inc.
380 Commerce Blvd.
Athens GA 30606
T 706.549.6787
info@usformliner.com
usformliner.com

Responsible Agency
ONEWORX GmbH, www.oneworx.de
Mathildenstraße 15a, 45130 Essen, Deutschland

3D-Visualization
S. 12 ipd3d, www.ipd3d.com
S. 14/15 ipd3d, www.ipd3d.com

